

Resource Allocation in LTE Advanced for Different Services

Neeraj Kumar¹, Anwar Ahmad²
^{1,2}ECE Department, Jamia Millia Islamia, New Delhi
¹neeraj.mohiwal@gmail.com, ²aahmad4@jmi.ac.in

Abstract:

Communication system can perform different types of services in communication network. LTE-Advanced system allocates radio resources for these services through a radio resource manager (RRM). Different types of services, such as real time (RT) services, non-real time (NRT) services, control signalling, are dynamically active in network and therefore these services require dynamic resource allocation for transmitting corresponding data packets. A scheduler in RRM needs to satisfy demand of these services with limited radio resources. Therefore, scheduler should be efficient in performing radio resource allocation in such dynamic environment. Current paper proposes, in a LTE-Advanced network, a resource scheduling method for managing different services. Proposed method tracks adaptive behaviours of communication services based on number of active users, data buffer status, channel condition. Results of proposed method are compared with existing methods and it is shown that current solution provides better results than existing methods.

Keywords: LTE-Advanced, service class, traffic, radio resource manager, resource scheduler.

1. Introduction

LTE (Long Term Evolution) is a fourth generation (4G) technology is developed from GSM (2G) and UMTS(3G) telecommunication technology. LTE is a 3GPP standard. High mobile data utilization, mobile gaming, high multimedia applications, web 2.0, mobile television etc. are main inspiration to develop LTE (4G) standard. It provides high throughput up to 300MBPS in downlink and up to 5MBPS in uplink. It is a complete packet switching (PS) system implementing an OFDM technology.

LTE standard does not fulfil International Telecommunication Union (ITU) recommendation. So, it is not a complete 4G technology, rather it is a 3.9G technology. Therefore, LTE is further evolved as per guidelines of ITU and called as LTE-Advanced (LTE-A) i.e. a true 4G technology. LTE-Advanced provides up to 1GBPS data rate in downlink and up to 500 MBPS data rate in uplink. MIMO, relay technology, CoMP, carrier aggregation etc. provide such higher data rate and low latency in LTE-A.

In LTE, radio resources are divided into time and frequency resource elements. Resource elements in time axis are divided into number of OFDM symbols and in frequency

axis are divided into number of sub-carriers. Resource element (RE) is a smallest resource unit, which occupies a single sub-carrier and an OFDM symbol. A resource block (RB) is a minimum resource allocation unit to any single user. One resource block occupies 12 sub-carriers and 6/7 OFDM symbols. Therefore, a resource block can have total 72/84 resource elements. The technology supports flexible bandwidths such as 1.4MHz, 3MHz, 5MHz, 10MHz, 15MHz and 20MHz. Each bandwidth can have different number of resource blocks i.e. 6, 15, 25, 50, 75 and 100 resource blocks (RBs) respectively. LTE standard suggests five different physical channels in downlink, which are PDCCH, PDSCH, PBCH, PCFICH, and PHICH [1]. PDCCH channel is a control channel and PDSCH channel is a shared data traffic channel. Number of resource blocks are allocated to these channels in 1ms transmit time interval (TTI) sub-frame [2]. A LTE radio frame of 10ms contains total 10 sub-frames, each of 1m. Each sub-frame [3] contains two resource blocks (RBs) of 0.5ms duration. Figure 1 suggests radio resource block structure according to LTE technology.

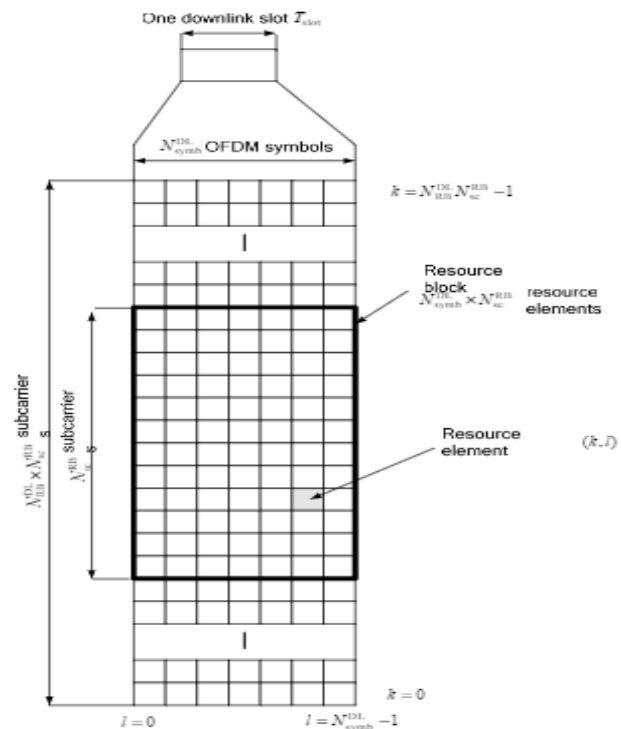

Fig. 1. LTE resource block structure

There are number of resource allocation methods are available in literature. Different survey papers suggest [4-6] different scheduling methods utilize in LTE. Figure 2 suggests a general resource allocation block diagram. Radio resource manager (RRM) is a main component for scheduling resources. A packet scheduler or PDSCH scheduler allocates resources based on various parameter considerations, such as channel condition, buffer status, queue length, previous average data rate, fairness, delay etc.

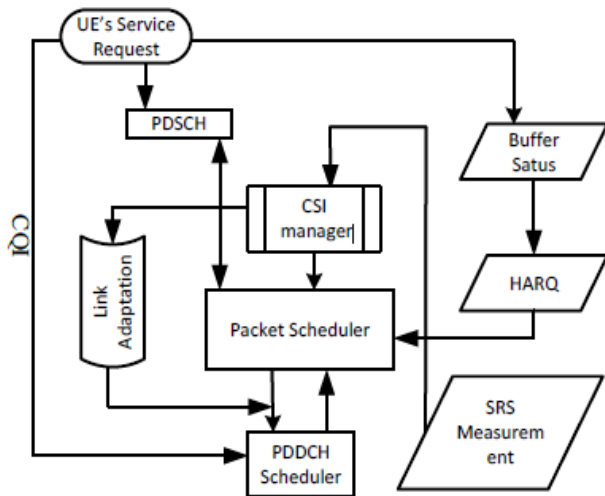

Fig. 2. A general traffic scheduler

In survey papers, various methods for resource scheduling are explained. Research paper [7] shows performance comparison in basic techniques i.e. proportional fairness (PF) and round robin techniques. It suggests that PF technique provides high fairness but moderate throughput. However, it does not differentiate service types for scheduling perspective. In [8], a way of improving QoS in proportional fairness technique is suggested. Similarly, in [9] also adaptive QoS for PF techniques is described. However, these techniques have not vision to check active service type before resource scheduling. Dynamic service behaviour requires dynamic resource allocation. In [10], different types of service and their scheduling are described. It shows optimization techniques for service prioritization in which weights of service types are optimized. However, it does not consider the traffic arrival rate, number of users, channel condition etc. for resource allocation. Weighing factor-based resource allocation is also explained in [11]. Data buffer and channel information-based scheduling technique is described in [12], which does not consider service types for scheduling. In network, a scheduler should consider service type, its arrival rate, data queue length and number of active users in resource allocation. Current paper proposes a resource scheduler having inter-class scheduler and intra-class scheduler. The scheduler schedules resources based on arrival rate, data queue length and number of active users and channel conditions.

2. System Model & Design

Scheduling model based on proposed method is shown in figure 3. In general, any scheduling model should be proposed such that it reflects practical environment of network. It should be reliable and flexible enough to accommodate various services. Therefore, suggested scheduling model utilizes poison traffic model for different communication services. Poison traffic model [13] is an oldest and robust communication traffic model. In network, various types of services are presented, and scheduler should manage its resources according to demand of services. These various services are type of various classes such as real time, not real time etc. There are mainly four types of service classes as shown in table 1.

Table 1: shows different types of service classes and their examples

Service class type	Example
Control Signalling	IMS signalling
Real time (RT)	Voice
Non real time (NRT)	Streaming video
Best Effort (BE)	Email, SMS

It is considered that current scheduler interacts with these various types of services. Let, each service of class C has mean arrival rate is λ_c which is represented in terms of poison traffic model. Further, each service of class type C is performed by number of users M_c with total data packet queue length Q_c . The poison traffic model equation for any service class C is defined as shown in equation 1.

$$F_c(t) = M_c Q_c e^{-\lambda_c t} \quad (1)$$

To perform a service, it requires sufficient number of resource blocks to transmit its service data packets. Numbers of resource blocks K are depending on available bandwidth in a network. The scheduler schedules K physical resource blocks (RBs) to total M users corresponding to all services. Number of users, M , are sum of all users in each service class type.

Each service class C experiences λ_c arrival rate through M_c users, wherein each user of class C has its own data packet whose packet queue length is defined as q_{ic} . Total packet length Q_c of any service class C is defined as below.

$$Q_c = \sum_{i=1}^{M_c} q_{ic}$$

$$M = \sum_{c=1}^C M_c$$

As shown in figure 3, current scheduler consists of two types of internal schedulers. One of the internal schedulers is an

inter service class scheduler which is followed by another internal scheduler i.e. intra service classes scheduler. Inter service class scheduler allocates number of resource blocks for each service class type based on total users, packet length and mean arrival rate.

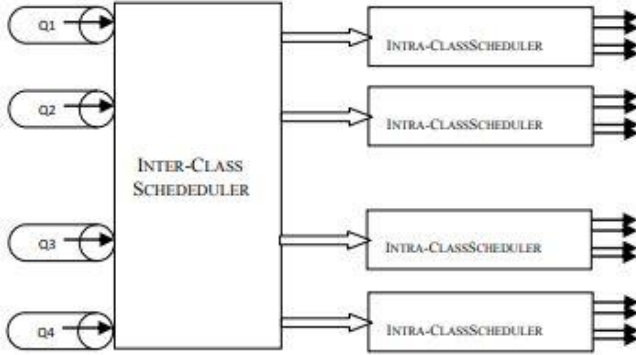

Fig. 3. Scheduler based on proposed method

Further, intra service class scheduler allocates received number of resource blocks to its users based on its user packet length and channel condition. Current scheduler allocates resources if condition shown in equation 2 exists.

$$Q_1\lambda_1 + Q_2\lambda_2 + Q_3\lambda_3 + Q_4\lambda_4 \leq BW \quad (2)$$

The BW is current bandwidth of system. There is mismatch may exist, i.e. required numbers of resource blocks are more or less than BW . Required numbers of resource blocks all services are defined as in equation 3. Note that numbers of resource blocks are depended on system bandwidth i.e., $K_{desired} \propto BW$.

$$Q_1\lambda_1 + Q_2\lambda_2 + Q_3\lambda_3 + Q_4\lambda_4 = K_{desired} \quad (3)$$

If $K_{desired}$ for number of services are less than bandwidth BW , then number of resource blocks are simply scheduled. However, if $K_{desired}$ for numbers of services are greater than bandwidth BW i.e. condition shown in equation 4 exists, it is required to prioritize service classes, so that this above-mentioned condition is avoided.

$$Q_1\lambda_1 + Q_2\lambda_2 + Q_3\lambda_3 + Q_4\lambda_4 > BW \quad (4)$$

Service class prioritization is depended on arrival rate, queue length and number of users. A service class C can have maximum throughput is decided by bandwidth and signal to noise ratio. Shannon Hartley theorem suggests maximum throughput in equation. 5.

$$C_{max} = M\lambda \frac{BW}{N} \log(1 + SNR) \quad (5)$$

The λ is a total arrival rate of all four types of services classes i.e.

$$\lambda = \lambda_1 + \lambda_2 + \lambda_3 + \lambda_4 \quad (6)$$

Expected throughput of all services of different classes is given by equation. 7.

$$C_{exp} \propto M_1Q_1\lambda_1 + M_2Q_2\lambda_2 + M_3Q_3\lambda_3 + M_4Q_4\lambda_4 \quad (7)$$

$$C_{exp} = \sigma(M_1Q_1\lambda_1 + M_2Q_2\lambda_2 + M_3Q_3\lambda_3 + M_4Q_4\lambda_4) \quad (8)$$

where σ is a resource proportional constant, which value is between 0 to 1. Scheduler allocates the resources if

$$C_{exp} \leq C_{max} \quad (9)$$

$$C_{exp} / C_{max} \leq 1 \quad (10)$$

$$\frac{\sigma(M_1Q_1\lambda_1 + M_2Q_2\lambda_2 + M_3Q_3\lambda_3 + M_4Q_4\lambda_4)}{M\lambda \frac{BW}{N} \log(1 + SNR)} \leq 1 \quad (11)$$

$$\frac{\sigma N(M_1Q_1\lambda_1 + M_2Q_2\lambda_2 + M_3Q_3\lambda_3 + M_4Q_4\lambda_4)}{M\lambda \log(1 + SNR)} \leq BW \quad (12)$$

Equation 12 shows similar structure as shown in equation 2 for resource allocation. A priority matrix for different service prioritization is shown below.

$$PM_c = \frac{M_c M_c \lambda_c C_{exp}}{Q_c C_{max}} \quad (13)$$

According to equation 12, the class-based priority matrix is given as in equation 14.

$$PM_c = \frac{M_c \lambda_c \sigma_c N(M_1Q_1\lambda_1 + M_2Q_2\lambda_2 + M_3Q_3\lambda_3 + M_4Q_4\lambda_4)}{Q_c M\lambda \log(1 + SNR)} \quad (14)$$

Priority matrix PM_c is designed in inter service class scheduler, so that it allocates total number of resources blocks individually for each service class type. The value of σ_c is different for different service class types. Output corresponding to respective service class of inter service class scheduler is given to respective intra service class scheduler. The intra service class scheduler receives total number of resource blocks and allocates these resource blocks to corresponding users. The resource allocation is varied for each user based on experienced channel condition and its data packet queue length q_{ic} . The user Resource allocation metric of intra service class scheduler is given as in equation 15.

$$PM_{ic} = PM_c * \frac{q_{ic}}{Q_c} * \frac{R_{exp}^i}{R_{avg}^i} \quad (15)$$

The R_{exp}^i is current expected data rate of user i of service class C and R_{avg}^i is average received data rate of user i of service class C .

For the LTE-advanced network a user can be scheduled by RRM with number of carriers, so in resource block allocation equation derived above can be for LTE-Advanced network. In equation, here, we are considering that there are five carriers (maximum in carrier aggregation) can be allocating to users.

The equation updated for carrier aggregation supporting users is:

$$PM_c = \frac{M_c \lambda_c \sigma_c N (M_1 Q_1 \lambda_1 + M_2 Q_2 \lambda_2 + M_3 Q_3 \lambda_3 + M_4 Q_4 \lambda_4)}{Q_c M \lambda \log(1 + SNR)} \quad (14)$$

Here, PM_c means total number of users of same class and supporting same number of carriers.

SIMULATION AND RESULTS COMPARISON

A. Simulation parameters

Proposed scheduling method is simulated using LTE-Advanced system toolbox in MATLAB. Various simulation parameters are disclosed below which are utilized for proposed method simulation. It is considered that in a LTE cell, users are uniformly distributed. In the centre of the cell, the base station eNodeB is positioned, whereas the users are modeled according to a random mobility model. The simulation parameters and the considered traffic model are provided in table 2.

Table 2: Scheduling parameters

Parameters	Value
System Bandwidth	10 MHz
Number of RBs	50
Subcarriers per RB	12
Frame Structure	FDD
Carrier Frequency	2.1 GHz
Simulation Time	10 Sec
Transmission Time Interval	1000 TTI
Cyclic prefix	Normal
UE Mobility Model	Random direction

Traffic model	Poisson Traffic
Service class types	RT, NRT, Control Data, Best effort flow services
MCS	QPSK, 16QAM, 64QAM
Scheduler	Round robin, Maximum throughput, Proportional fair

B. Performance calculation parameter

Fairness parameter: This performance parameter provides equal opportunity to users in accessing of resources. The parameter is provided in terms of Jain's fairness index.

$$f(x) = \frac{(\sum_{i=0}^n x_i)^2}{n \sum_{i=0}^n x_i^2}$$

System Throughput: System throughput at a given time is calculated by the sum of average achieved throughput across all users performing various services such as real time, non-real time and best effort services.

C. Simulation Results:

This section discusses performance of proposed scheduling method based on performance parameters i.e. fairness, system throughput. Different service classes have different priorities. Service class type of control signalling has highest priority, so resource blocks are allocated to control signalling without delay. Further, control signalling information are mainly sent on control channels and remaining three service classes information are sent on shared data channel. So, here in various results show only performance of remaining three service classes i.e. real time, non-real time and best effort services allocated in shared data channel.

Figures 4(a) to 4(d) show a comparison of system throughputs corresponding to services i.e. as real time, non-real time and best effort services.

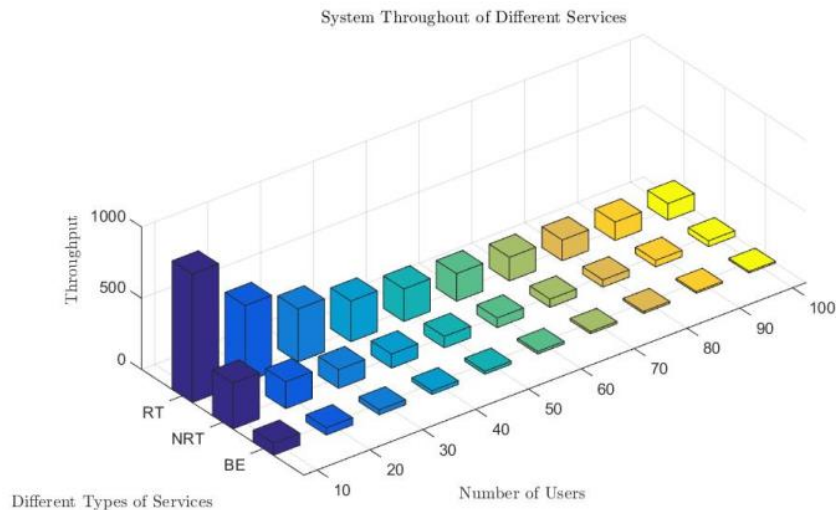

4 (a)

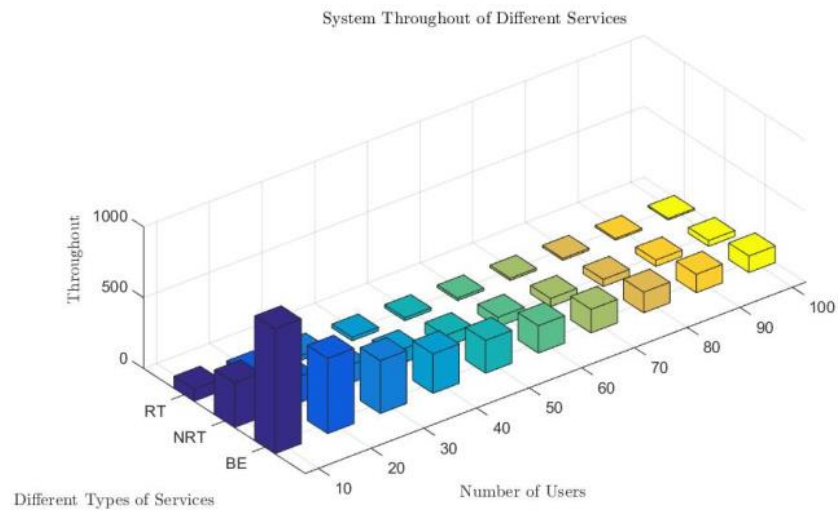

4 (b)

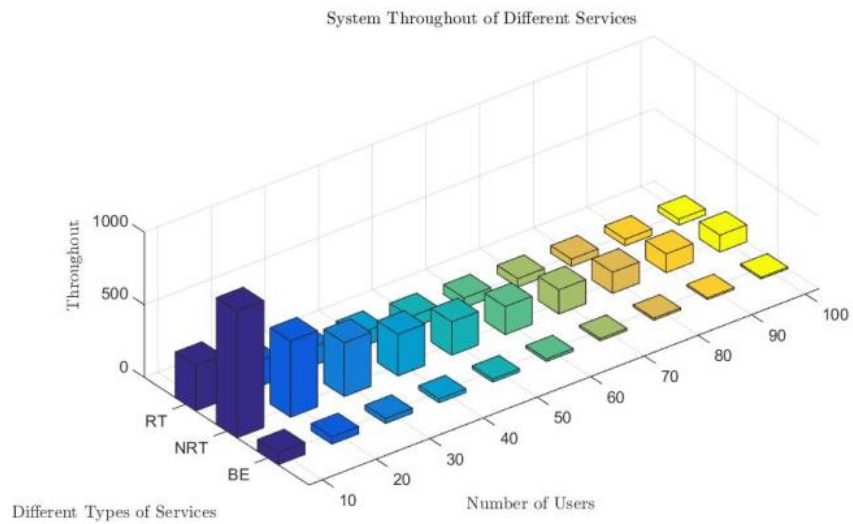

4 (c)

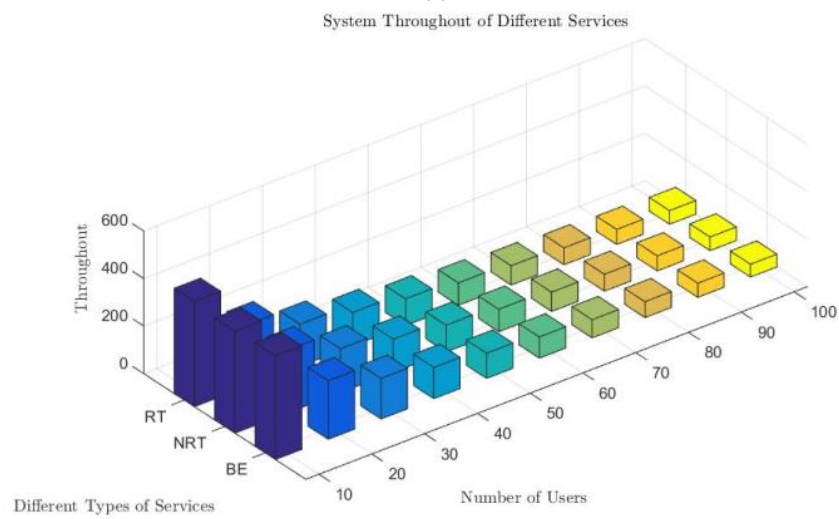

4 (d)

Fig. 4(a) - 4(d). Throughputs corresponding to different proportional of services i.e. real time (RT) service, non real time (NRT) service and best effort (BE) service

Table 3 shows different proportion of services in each simulation corresponding to figures 4(a) to 4(d). It is very clear from figures, the service which has higher proportion in comparing to other services, gets more resources. Dynamic change in service proportion reflected in resource allocation. Figures 4(a) shows real time service receives highest throughput in comparison to other non real time services and best effort services. Figures 4(b) shows best effort services receives highest throughput in comparison to other real time and non real time services. Figures 4(c) shows non-real time service receives highest throughput in

comparison to real time services and best effort services. Similarly, in figures 4(d) shows real time service receives highest throughput in comparison to other non real time services and best effort services.

In figure 5, fairness comparison of different services. It shows that it service class is fairly scheduled based on corresponding proportion of services i.e. real time services, non-real time services and best effort services. Fairness and throughput are reducing as number of users are increasing, however, current method provides high fairness and throughput at low number of users.

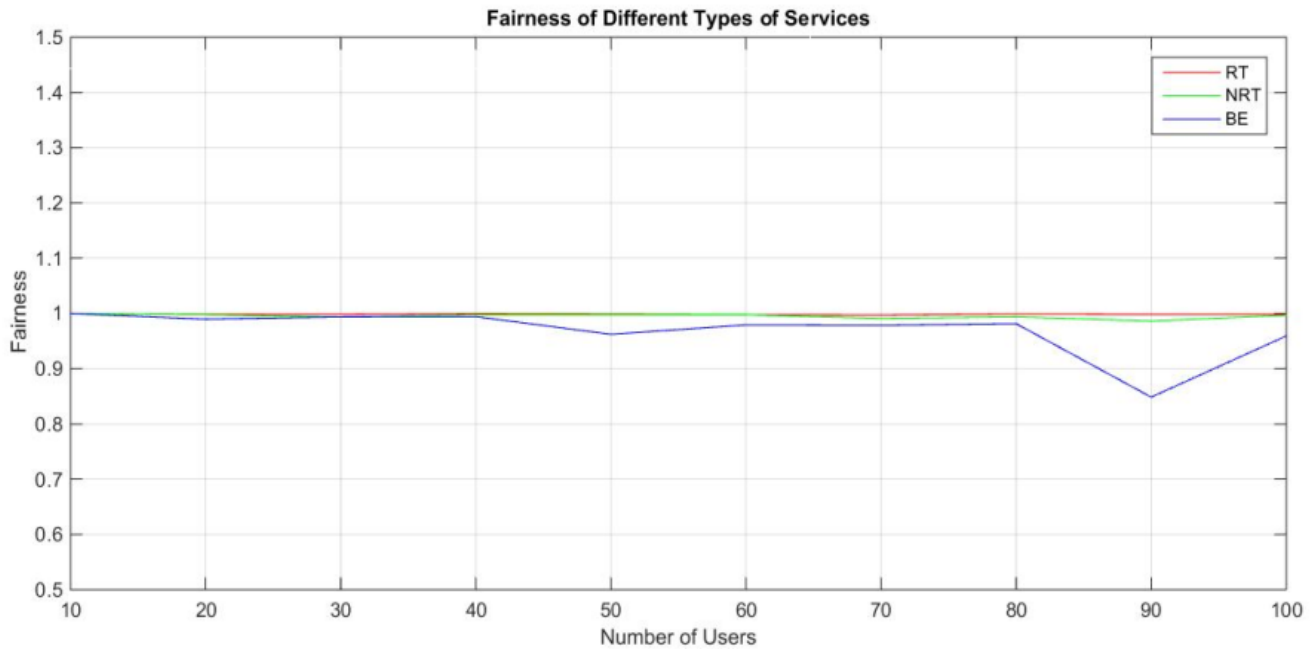

Fig. 5. Fairness comparison in real time (RT) service, non-real time (NRT) service and best effort (BE) service

Table 3: Figure Numbers and Service Proportions

Figure Number	Service Proportion		
	RT	NRT	BE
4(a)	70%	25%	5%
4(b)	5%	25%	70%
4(c)	25%	70%	5%
4(d)	34%	33%	33%

Figure 6 shows throughput comparison of proposed method with conventional techniques i.e. proportional fairness and best CQI. Proposed method has higher throughput than proportional fairness (PF) technique due to PF techniques average out services best on past history of users. Further, it does not consider service differentiation during resource allocation. However, current method has lower throughput than best CQI technique. Best CQI techniques has highest throughput due to it allocates resources based on best instantaneous channel condition whereas proposed method has allocated resource based on ratio of instantaneous channel condition, average received throughput, based on queue length, number of active users and mean arrival traffic rate. As numbers of users are increasing, throughput of proposed method is also increasing.

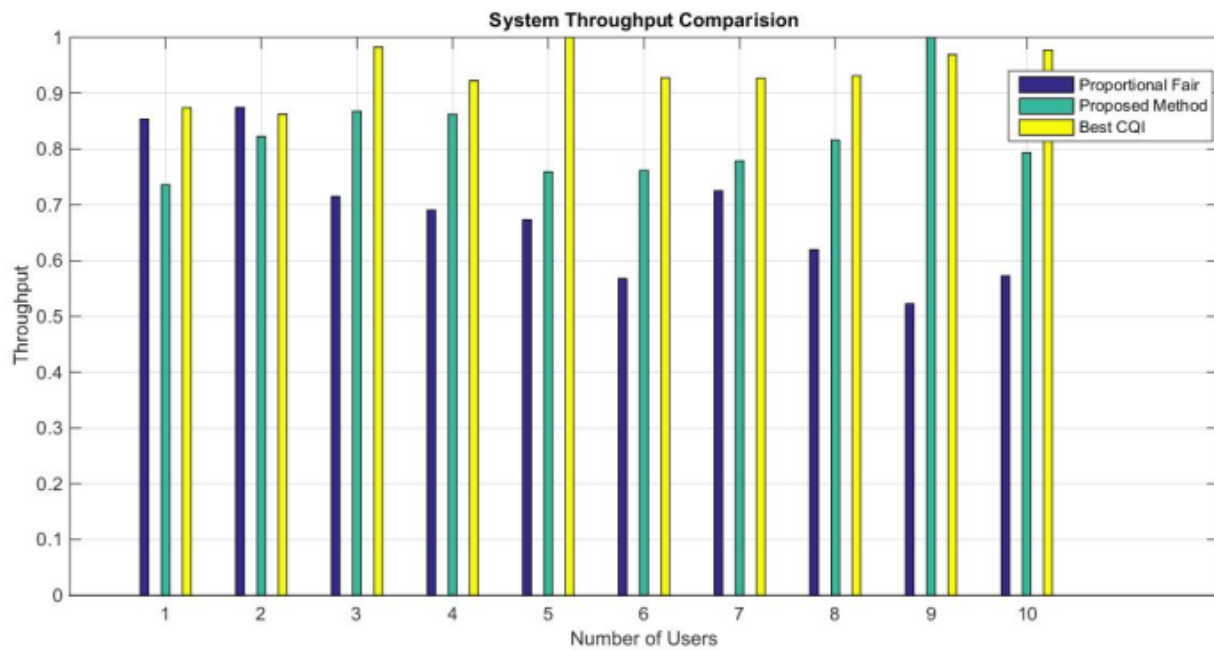

Fig. 6. Throughput comparison of techniques.

Figure 7 shows fairness comparison of proposed method with conventional techniques i.e. proportional fairness and best CQI. Fairness from proposed method is achieved close to the proportional fairness. PF technique does not differentiate service types, so it equally treats to all services

whereas current method differentiates service types and allocates resource fairly to each type of services. Best CQI has lowest fairness as it does not consider past throughput of users during resource allocation.

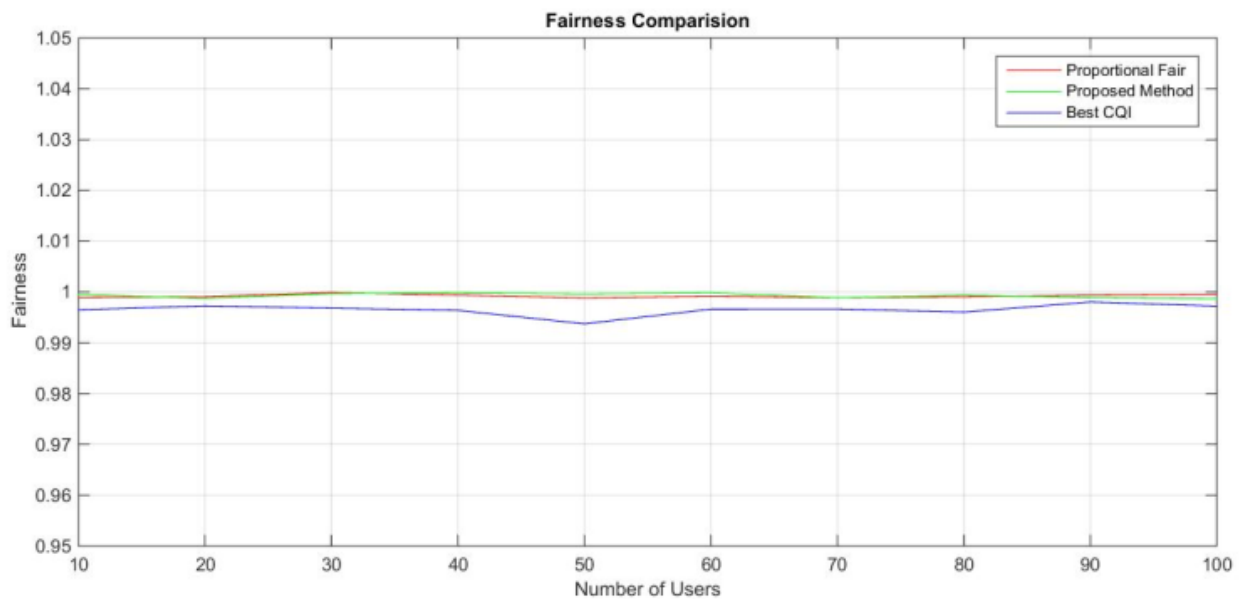

Fig. 7. Fairness comparison of techniques.

CONCLUSION

Proposed method discusses, in an LTE-Advanced, a dynamic resource allocation method based on inter-class scheduler

and intra-class scheduler. Inter-class scheduler allocates number of resource blocks to each service based on service class prioritization. A service class is prioritized based on mean arrival rate of poison traffics, number of users and data

packet queue length. Then, intra-class scheduler allocates resources to users based on received number of resource blocks from inter-class scheduler. Results of current method are better than conventional techniques. It provides higher throughput and fairness based on service class proportion. In future, an optimization technique can be possible for current method in future as optimization will help in fast resource allocation in current dynamic network.

REFERENCES

- [1] 3GPP TS 36.211 v12.5.0, 3GPP Evolved Universal Terrestrial Radio Access (E-UTRA); Physical Channels and Modulation, March 2015.
- [2] 3GPP TS 36.212 v12.4.0, 3GPP Evolved Universal Terrestrial Radio Access (E-UTRA); Multiplexing and Channel Coding, March 2015.
- [3] 3GPP TS 36.213 v12.5.0, 3GPP Evolved Universal Terrestrial Radio Access (E-UTRA) Physical Layer Procedures, March 2015.
- [4] F. Capozzi, G. Piro, L. Grieco, G. Boggia, and P. Camarda, "Downlink packet scheduling in LTE cellular networks: Key design issues and a survey", *IEEE Communications Surveys Tutorials*, vol. 15, no. 2, pp. 678-700, 2013.
- [5] Abu-Ali, Najah; Taha, Abd-Elhamid M. ; Salah, Mohamed ; Hassanein, Hossam "Uplink Scheduling in LTE and LTE-Advanced: Tutorial, Survey and Evaluation Framework", *IEEE*, 2014.
- [6] A.S. Hamza, S. S. Khalifa, H. S. Hamza and K. Elsayed, "A Survey on Inter-Cell Interference Coordination Techniques in OFDMA-based Cellular Networks,". *IEEE Comm. Surveys & Tutorials*, 2013.
- [7] Mohammad T. Kawser, Hasib M. A. B. Farid, Abduhu R. Hasin, Adil M. J. Sadik, and Ibrahim K. Razu, "Performance Comparison between Round Robin and Proportional Fair Scheduling Methods for LTE", *International Journal of Information and Electronics Engineering*, Vol. 2, No. 5, Sept 2012.
- [8] Martin Klaus Muller, Stefan Schwarz and Markus Rupp, "QoS Investigation of Proportional Fair Scheduling in LTE Networks", *Wireless Days (WD)*, 2013 IFIP.
- [9] Hung-Chin Jang and Chien-Piao Hu, "Fairness-Based Adaptive QoS Scheduling for LTE" *IEEE International Conference on ICT Convergence (ICTC)*, page 626-631, 2013.
- [10] Rehana Kausar, Yue Chen, Kok. Keong. Chai, "An Intelligent Scheduling Architecture for Mixed Traffic in LTE-Advanced", *23rd IEEE International Symposium on Personal, Indoor and Mobile Radio Communications (PIMRC) 2012*. Sydney Australia, 9-12 Sep. 2012
- [11] J. Chen, L. Zhu, Q. Wu, Z. Shen, "Multi-services supporting weighted power scheduling algorithm based on LWDF", *IEEE international conference on wireless communications and signal processing (WCSP) 2010*, pp. 1-5.
- [12] P. Parag, S. Bhashyam, and R. Aravind, "A subcarrier allocation algorithm for OFDMA using buffer and channel state information", *IEEE vehicular technology conference, VTC-2005-Fall, 2005*, pp. 622-625.
- [13] A. Adas, "Traffic models in broadband networks", *IEEE communication magazine*, Vol. 35, issue 7, July 1997, pp. 82-89.